



Electrak[®]

E12, E15, E20 Tractor

GEZ-5338A



ROTARY MOWER

AA42

- Front mounted for trimming under and around bushes, trees, etc. Cuts the grass before the tractor rolls over it, greater visibility allows more cutting on every pass
- Mowers are available with either side discharge (best for long grass without grass pickup) or rear discharge — between wheels under tractor (safest and facilitates grass or leaf pickup with sweeper or vacuum)
- 3 blades and 3 motors provide large 42" cutting width
- Mower flips up for simple cleaning and easy blade changing or sharpening
- Blades stop in less than 3 seconds when operator leaves seat, switches PTO off, or turns off key



DUMP CART

AF12

- Large 12-cubic foot 1000-lb capacity (4' x 3' x 1')
- All steel body with full-length bottom reinforcing channels
- Removable rear tail gate slides between reinforced channels
- Stake pockets for adding side extensions
- Spring-loaded latch for dumping. Locks itself



LAWN SWEEPER

AS31

- Electric-motor kit (KS31) provides superior sweeping at a constant speed
- 31" sweeper brush, sweeps an area wider than the discharge width of the 42" ELEC-TRAK rear discharge mower
- Convenient rear dump and brush height adjustment from the driver's seat
- Light duty dethatching can be done with powered sweeper

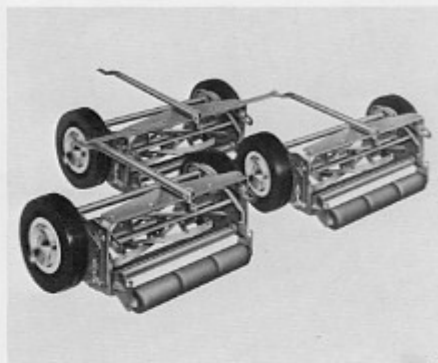

GANG MOWER

AR57

- 3-gang reel mower cuts 57" width
- Easily adjustable from 1/2" to 2-1/2" cutting height of 5-gang reel
- 6 tempered blades and heat-treated bedknife
- Universal hitches allow attachment of up to 5-gang reel



Elec-Trak

FOR WINTER



42" SNOW THROWER AD42

- Instant on. Safety interlock with tractor seat switch
- High torque, single-stage direct chain drive auger works independently of tractor speed
- Discharge chute rotates 270° from tractor seat
- Adjustable skid shoes
- Raise or lower electrically with standard tractor lift
- Requires AP85 weight box



48" DOZER BLADE AB48

- Large 48" blade width
- Angle adjustment controlled from driver's seat
- Height of blade controlled by standard electric tractor lift
- Replaceable wear blade is adjustable to vary the blade attack
- Blade trip springs protect against damage
- High traction/torque of ELEC-TRAK tractor makes dozing heavy loads easy



SNOW CAB AG55

- Simple and rugged steel construction for strength and ease of assembly
- Large safety-glass windshield with electric windshield wiper
- Snap-in nylon reinforced curtains with vinyl windows for winter
- Easy entry into cab with large zippered doorway
- A convenient pocket flap opening allows easy access to operate snow thrower or dozer blade

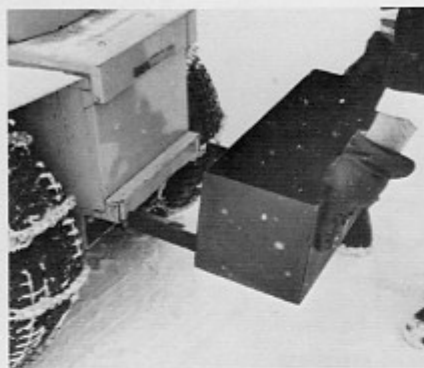

WEIGHT/TOOL BOX AP85

- Required for use with Snow Thrower for best traction (Included in Snow Thrower Package)
- Weight box locks into rear stabbers
- Will hold 200 lbs of ballast (5 standard 4" concrete blocks at 40 lbs) or carry tools, accessories

CHAINS

- Chains for 8:50 tires, 2 links AP65
- Chains for 9:50 tires, 4 links AP66
- Chains for 9:50 tires, 2 links AP68



48" V-PLOW BV48

- High-speed sidewalk plowing
- Clears a 48" path through snow
- 18" high, heavy-duty all-steel blades
- Replaceable steel wear bar on each blade
- Raise or lower electrically with standard tractor lift
- With three gauge shoes for maintaining height adjustment



**TRACTOR COVER AP80
MOWER COVER AP81**

- Made of strong, durable, black, vinyl-coated nylon
- Designed for temperatures to -40°F
- Has air vents for good air circulation
- Easily mounted on tractor or mower with an elastic shock cord hem

FOR YARD GROOMING



POWER HANDLE TM3

- 36-volt power unit
- Plugs into tractor accessory outlet
- Takes drill, grass trimmer, and hedge trimmer heads

DRILL

- TH20 drill head – takes up to 1/4" drills
- TH30 drill head – takes up to 3/8" drills

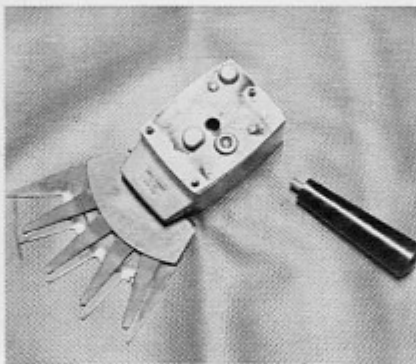

GRASS TRIMMER HEAD TH80

- Ideal for cutting around trees, rocks, along stone walls, under fences
- Has built-in clutch which will slip to prevent damage to the mechanism should hard objects get into blades
- Fits GE TM3 power unit.

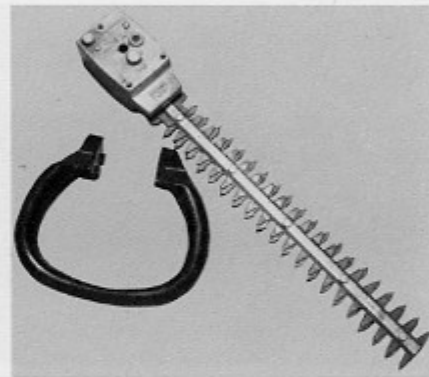

HEDGE TRIMMER HEAD TH70

- Double-edge 15" steel blades with reciprocating motion
- Helper handle makes it easy to use in horizontal or vertical positions
- Fits standard GE TM3 power unit



WEEDER/CULTIVATOR HC05

- Makes weeding, cultivating, or digging a garden easy
- Tills an area 5" wide, can dig down to 6" depth
- Easy to operate with trigger switch and only weighs 9 lbs.
- A long handle lets you stand up and keep clean
- Requires extension cord HT25

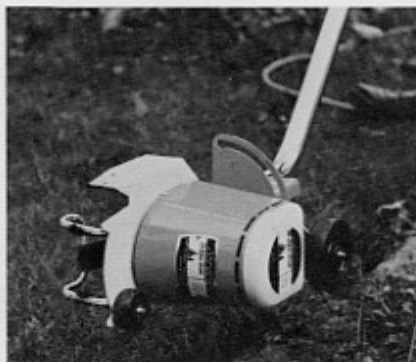

LAWN EDGER/TRIMMER HE06

- Use for edging or lawn trimmer
- Extra front wheels provides smooth edging
- A rear guard helps protect the operator
- Has a built-in anti-scrape guard for trimming
- A light 8½ lbs make long usage easy
- Requires extension cord HT25



ELECTRIC CHAIN SAW HS13

- Light weight
- Fast, high-speed cuts with Oregon Chain
- Instant on and off with trigger-type switch
- 13" bar will double cut up to 26" logs
- Plunger-type oiler forces oil into chain while cutting
- Complete with 20-foot cord and plug.



FOR GARDENING



TILLER (VV-100 Brinly) TILLER MOUNTING BRACKET (VV-101 Brinly)

- Tills 30" width
- Tills up to 20,000 sq ft at four-inch depth on one charge of tractor
- Tiller can be center mounted or offset to either side
- Mounts to axle with tiller mounting bracket
- Can be adjusted for two tilling angles
- Used with electric rear lift (AP59)

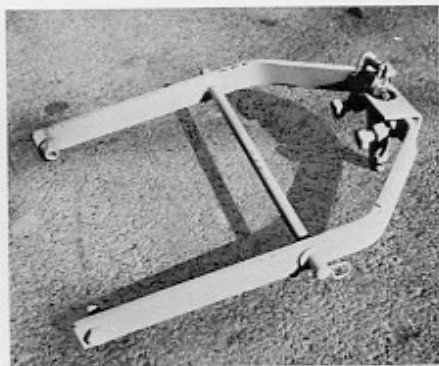

SLEEVE HITCH (AP50)

- Takes Brinly-Hardy implements built to industry standard for sleeve hitch implements
- Easy to attach with two bolts
- Can be used with electric or manual rear lift (AP59, AP58)

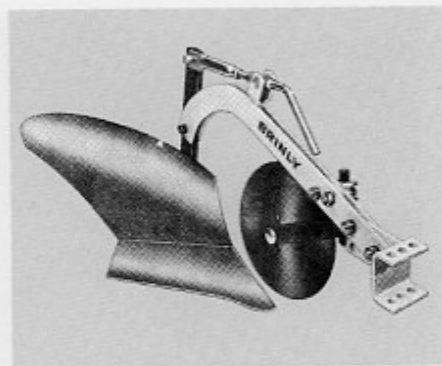

MOLDBOARD PLOW (PP510 - Brinly)

- 10" moldboard plow with adjustable hitch clevis for different plowing conditions
- Has an 11" rolling coultter that will swing out for trash clearance
- Secures to tractor with sleeve hitch (AP50)
- Quiet, high-traction ELEC-TRAK tractor makes plowing a pleasure
- Easy disengagement or transport with rear lift (AP58 or AP59)

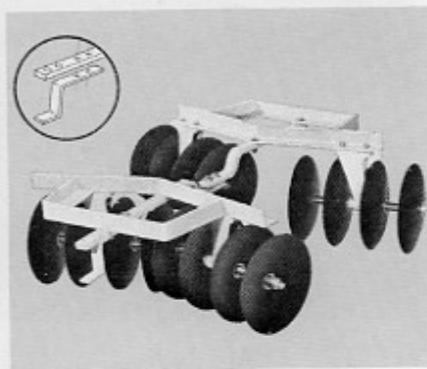

DISK HARROW (DD500 - Brinly)

- Has eight 11" diameter steel disk blades for cutting width of 29 to 39 inches
- Individual disks have a positive angling adjustment of 10, 15, and 20 degrees
- Angle weight box holds standard 16" concrete block
- Attaches to either sleeve hitch
- Easy disengagement or transport with rear lift (AP58 or AP59)

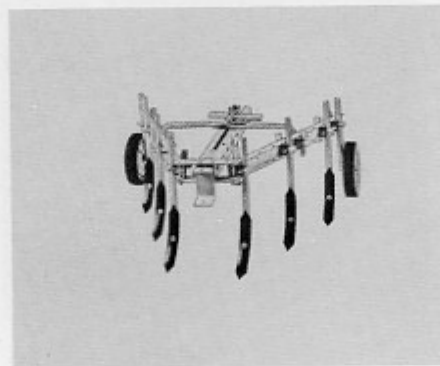

ROW CROP CULTIVATOR (CC500 - Brinly)

- A versatile unit for cultivating a wide range of crops
- Adjustable for rows from 6" to 42" wide
- Use for straddle-row, reverse position for between-row cultivation
- Equipped with 7 reversible shovels, gauge wheels, bolt and strap for holding weight block
- Easy disengagement or transport with rear lift (AP58 or AP59)

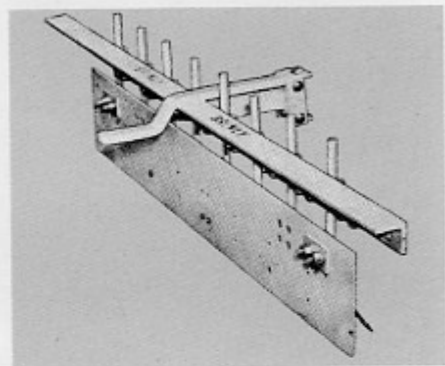

TOOL BAR (TT100 - Brinly)

- The tool bar, with appropriate accessories, extends the use of your tractor to many operations; including: light grading, scarifying, back-filling, finish grading, seed-bed preparation, hilling, covering, cultivating, disking and packing
- Consists of 5-ft long steel bar welded to heavy-duty hitch, with rear extension for attaching drags, etc.
- Easy disengagement or transport with rear lift (AP58 or AP59)

